



Dear Valued Customer,

The **next few pages** contain the information needed to prepare for the installation of your on-line film processor. Please make copies and get them to the people who will be responsible for each function.

Your cooperation will **help us** to **help you** reach **full production** as quickly as possible.

If you have any questions please call (800) 759-3956.

We need you to confirm that you have received this fax before we can ship your processor. Please indicate the number of pages you have received, and fax your signed confirmation to 920-563-4868.

I received \_\_\_\_\_ pages of preinstallation information.

Name: \_\_\_\_\_ Date: \_\_\_\_\_

Thank you,  
Sincerely

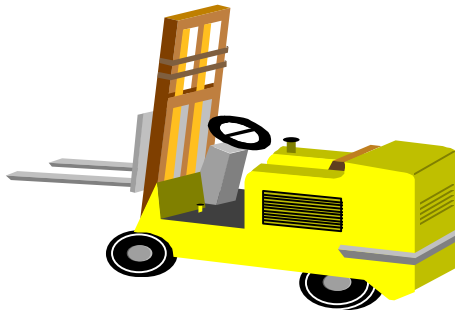

\*\*\*\*\*  
**NOTE RECEIVING DEPARTMENT**  
**You are Liable for the Inspection of These Indicators.**  
\*\*\*\*\*

The shipping crate has **two indicators** on it. These are used to monitor the handling of the crate during shipment. The trucker's bill of lading will note that these indicators are on the crate. One will be a "Drop and Tell" and the other a "Tip and Tell".

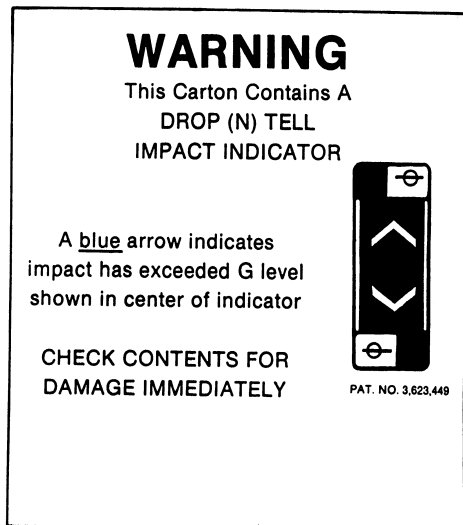

**WARNING**

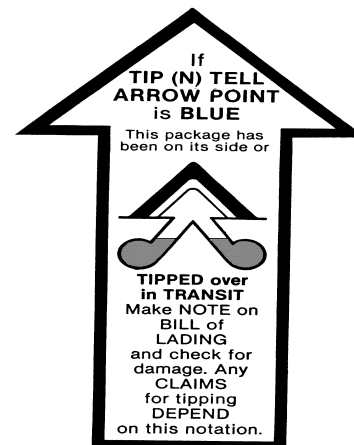

TIP (N) TELL

**Should either of these indicators be actuated or missing, or there is any visible damage to the crate, note it on the truckers bill of lading, before signing for the receipt of the processors.**

Direct any questions to the service department at (800) 759-3956.

## ON-LINE PROCESSOR REQUIREMENTS

State and local regulations for electrical and plumbing vary. Your local contractor is the one most qualified to provide the utilities in accordance with your local codes. If your contractor has any questions please have him call Carnfeldt at (800) 759-3956.

Your film and chemical supplier is also a source of information on local environmental requirements.

**THE ELECTRICAL AND PLUMBING, PROVIDED TO THE PROCESSOR, MUST BE READY BEFORE INSTALLATION !!**

FILM PROCESSORS SHOULD NEVER BE INSTALLED ON CARPETING. PROCESSORS INSTALLED IN CARPETED ENVIRONMENTS ARE SUSCEPTIBLE TO NUMEROUS PROBLEMS.



### Electrical Supply Requirements: EG901 Combi ( Heidelberg Primesetter 74 )

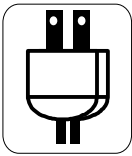

- 40 amp @ 230 volts A dedicated line that is free of any other equipment.  
VOLTAGE SUPPLIES LOWER THAN 220 WILL REQUIRE A BOOST TRANSFORMER.
- Single phase

### Plumbing Requirements:



- Standard water control panel containing:
  - water pressure regulator
  - flowmeter
  - hot & cold water mixing valve
  - water filter
  - at least two separate outlets with  $\frac{3}{4}$ " thread o.d.
- Floor drain recommended - any other drain no higher than 12" from floor.
- A sink large enough to accommodate a rack (approximately 46" long x 8" wide x 12" high), and with hot and cold water should be installed near the machine.

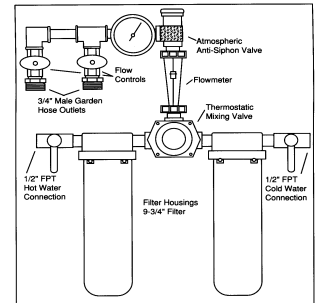

### Exhaust:

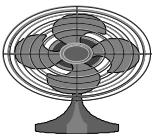

- Recommended exhaust rate 110 cfm (cubic feet per minute).
- The processor has a 4" diameter exhaust connection which connects to the building ventilation system.
- The processor **must be kept under exhaust during off-duty hours** so as not to allow evaporation to work back into the conveyor or imager.
- The processor comes with an internal exhaust blower capable of moving 110cfm through 4" diameter vent tubing for up to 12 feet, with one 90° bend in the tubing. Any other ventilation configurations will require additional exhaust assistance.

There are a variety of peripherals; such as replenishment systems, water recirculators, or silver recovery units that some choose to connect to the processor. Those who supply these peripherals are most familiar with their product. Therefore they should be present to install these pieces while our representative is there, so that:

- they are installed according to the product specifications and,
- the processor is not adversely affected (causing improper development, fixing, washing or exhausting).

NOTE: IN-LINE SILVER RECOVERY UNITS WILL REQUIRE AN ADDITIONAL FIXER CIRCULATION PUMP. CARNFELDT CAN SUPPLY THE ADDITIONAL PUMP AND HOSES AT A COST OF \$375.

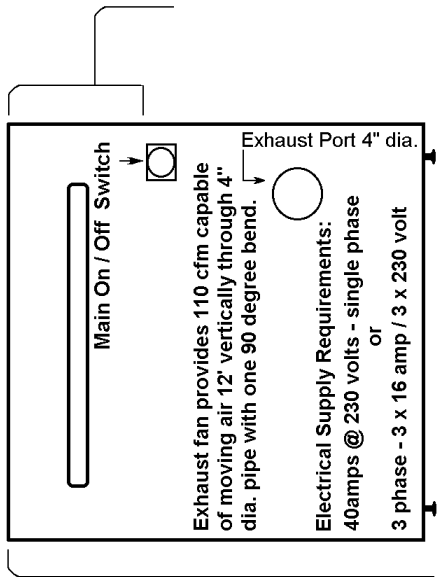

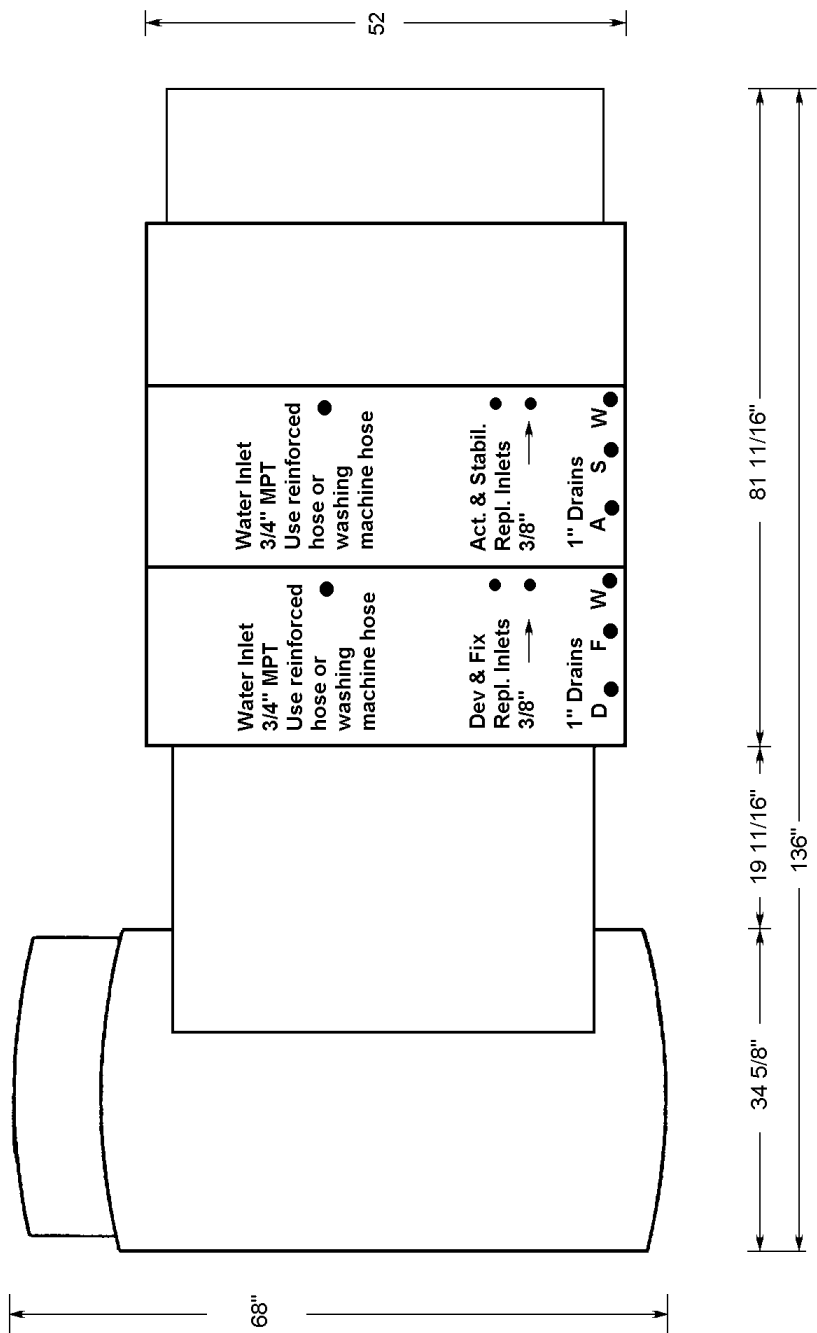
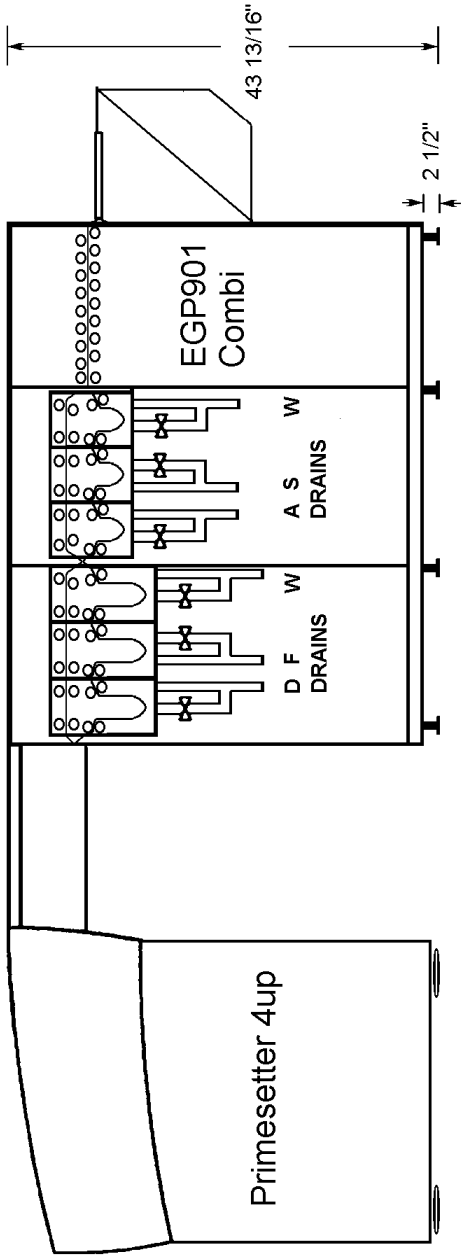

4" 52" 12 3/8"

Please allow 36" of working space on both sides and at the rear of the processor.



**CARNFELDT / HEIDELBERG**  
**Installation View**  
**Primesetter 4up EGP Combi**

# THE FOLLOWING ARE TO BE COMPLETED PRIOR TO THE INSTALLERS ARRIVAL.

- The equipment site has been surveyed and allowance been made for **adequate space** as recommended by the manufacturer. (Don't forget replenishment tanks, silver recovery equipment, wash water regulations, etc.)
- **Drains, electrical, exhaust and water services, are in place and functioning as recommended.**  
  
- Lay out the system position with chalk or tape on the floor using the measurements provided. This will assist the electricians and plumbers in positioning their utilities. It will also assist in placing any accessories (replenishment tanks, silver recovery, etc..).
- Any **existing equipment** is to be **removed** and the area prepared for new equipment.
- Contact Carnfeldt America for information if the processor is to be installed through the wall.
- **Chemistry and film** must be on hand along with the film manufacturer's rep.
- Arrange for an employee, **who will be responsible** for the care of the processor, to be available throughout the installation for purposes of familiarization with the equipment and operational training.

## CUSTOMER INSTALLATION AGREEMENT

Installations assume that **all** requirements and **conditions** stated above will be completed or **complied with prior to** the arrival of the **installer**.

Carnfeldt America and it's local agent will provide telephone technical assistance to the customer necessary to effect a smooth economical installation at no charge. This would include review of floor plans, electrical or plumbing requirements at the corporate or local representative's office.

The local agent will always try to make decisions, regarding its options in this agreement, in the interest of the customer and expediency. If a conflict should arise, every effort will be made to contact Carnfeldt America for consultation on the conflict resolution.

## WARRANTY

NOTE: The one year parts warranty begins when the processor is shipped; **unless** the warranty form is promptly filled out and **faxed** to 920 563 4868 on the date the installation is complete.

**NO WARRANTY PARTS WILL BE ISSUED UNTIL THE WARRANTY FORM IS FILLED OUT AND FAXED.**

Carnfeldt America, Inc.      W6637 Highway 12      Fort Atkinson, WI 53538      800 759 3956